

Sysmac Automation Platform

One Machine Control



One Machine Control

Motion, Logic and Vision in one

One machine control through one connection and one software is how we define the new Sysmac automation platform. The new NJ machine automation controller integrates motion, logic sequencing, vision and networking under one software: Sysmac Studio. This one software provides a true Integrated Development Environment (IDE) that includes a custom 3D motion simulation tool. The NJ controller comes standard with built-in EtherCAT and EtherNet/IP. The two networks with one connection purpose is the perfect match between fast real time machine control and data plant management.



One machine controller: NJ-Series

For complete control and management of your machine. Logic and advanced motion control in one

One connection: EtherNet/IP

For local or remote access to the complete machine



One machine network: EtherCAT

For real time control of servo drive, inverter, vision system and I/O

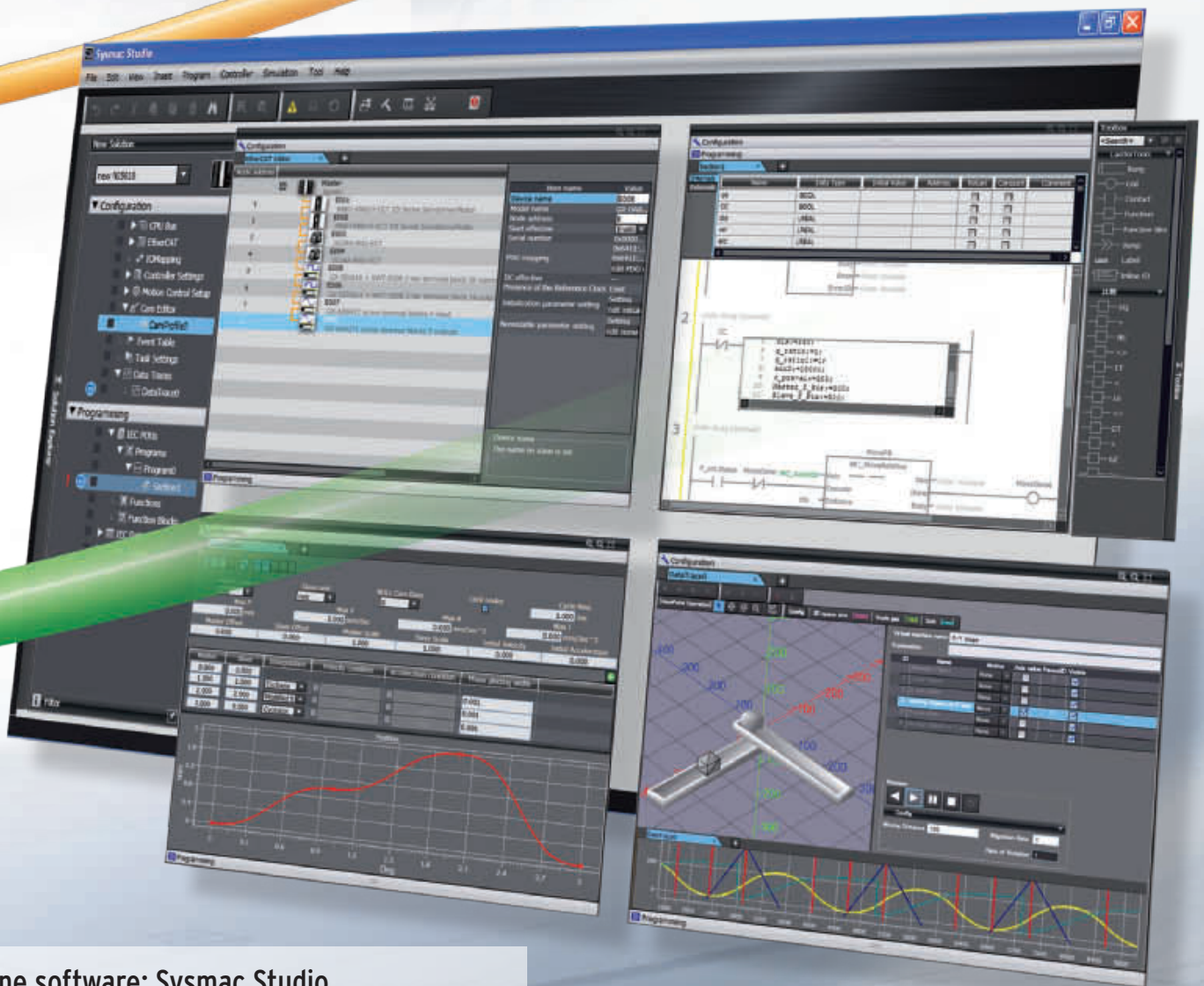

One software: Sysmac Studio

For configuration, programming, simulation and monitoring

One connection

One machine network

One connection via the NJ-Series controller allows seamless control and communication with both the machine and the factory. The new NJ-Series controllers join the world standard factory automation network, EtherNet/IP, with the best Ethernet-based machine control network, EtherCAT.

NJ-Series motion features

- » Up to 64 axis control
- » Complies with PLCopen Function Blocks for Motion Control
- » Linear, circular and spiral (helical) interpolation
- » Master slave functions: registration control, flying shear, etc.
- » E-cam with on the fly change



NJ-Series system features

- » Fast PLC tasks in 500 μ s
- » Programming and data types fully compliant with IEC 61131-3
- » Multi-tasking program
- » EtherCAT, EtherNet/IP embedded
- » SD card slot and USB port built-in
- » Works with most CJ-PLC modules
- » 10 years maintenance free

EtherNet/IP: the ONE factory automation network

- » Peer-to-Peer controller communication
- » Interface with NS HMI series or SCADA software
- » Interface to Sysmac Studio

IMAGE

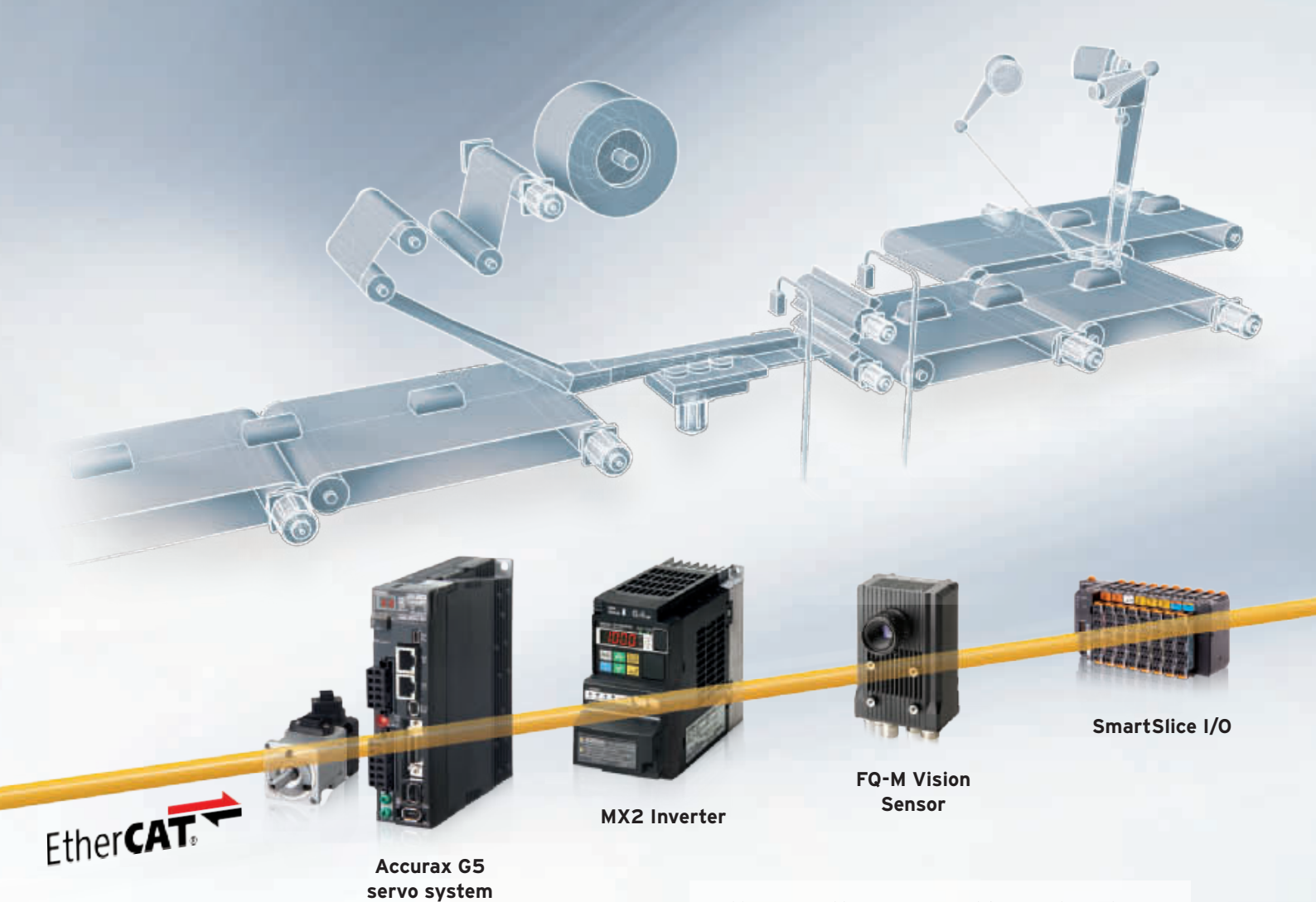

EtherCAT

**Accurax G5
servo system**

MX2 Inverter

**FQ-M Vision
Sensor**

SmartSlice I/O

EtherCAT: the ONE machine network

- » Up to 192 slaves
- » Fastest machine network on the market
- » Noise immunity to stringent Omron standards
- » Embedded in Omron servo drive, inverter, vision sensor and I/O
- » Uses standard STP Ethernet cable with RJ45 connectors



One connection

EtherCAT the optimal machine network

EtherCAT is the fastest emerging network for machine automation. It is Omron's de-facto machine network for our wide range of field and motion devices. It is Ethernet based, fast, accurate and highly efficient in terms of data transmission. All our EtherCAT devices have been designed and tested to meet Omron's stringent requirements on noise immunity.

Key features

- It is industrial Ethernet and uses standard IEEE 802.3 frames.
- It achieves high synchronisation accuracy by using a distributed clock mechanism.
- It is the fastest network on the market with 100 μ s refresh time and less than 1 μ s jitter
- It is simple to set up with automatic address assignment for nodes
- It uses standard Ethernet cables and connectors



Master clock

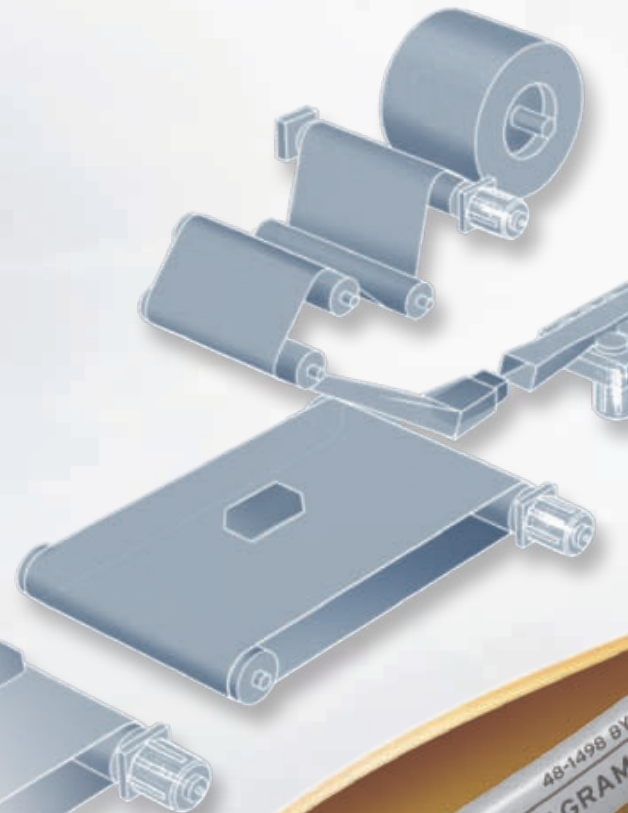

EtherCAT is Industrial Ethernet

The EtherCAT Telegram is contained in the Ethernet Data section of the IEEE 802.3 Ethernet frame. The frame travels through the media at 100 Mbps in full duplex mode.

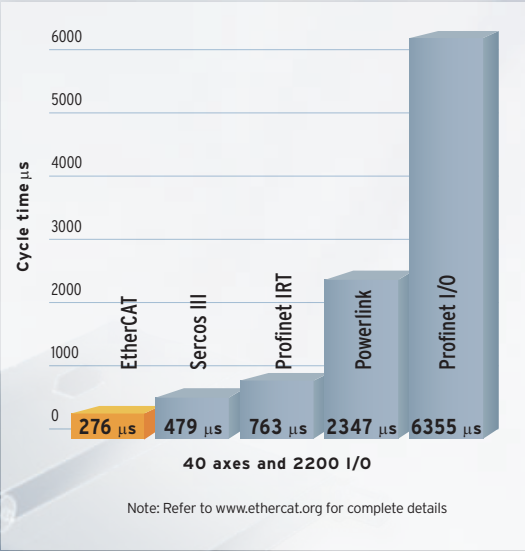

Simple cabling: 100Base-TX

EtherCAT uses standard 100BASE-TX Ethernet communication very efficiently, over standard shielded Ethernet cables and connectors. No need for network switches.

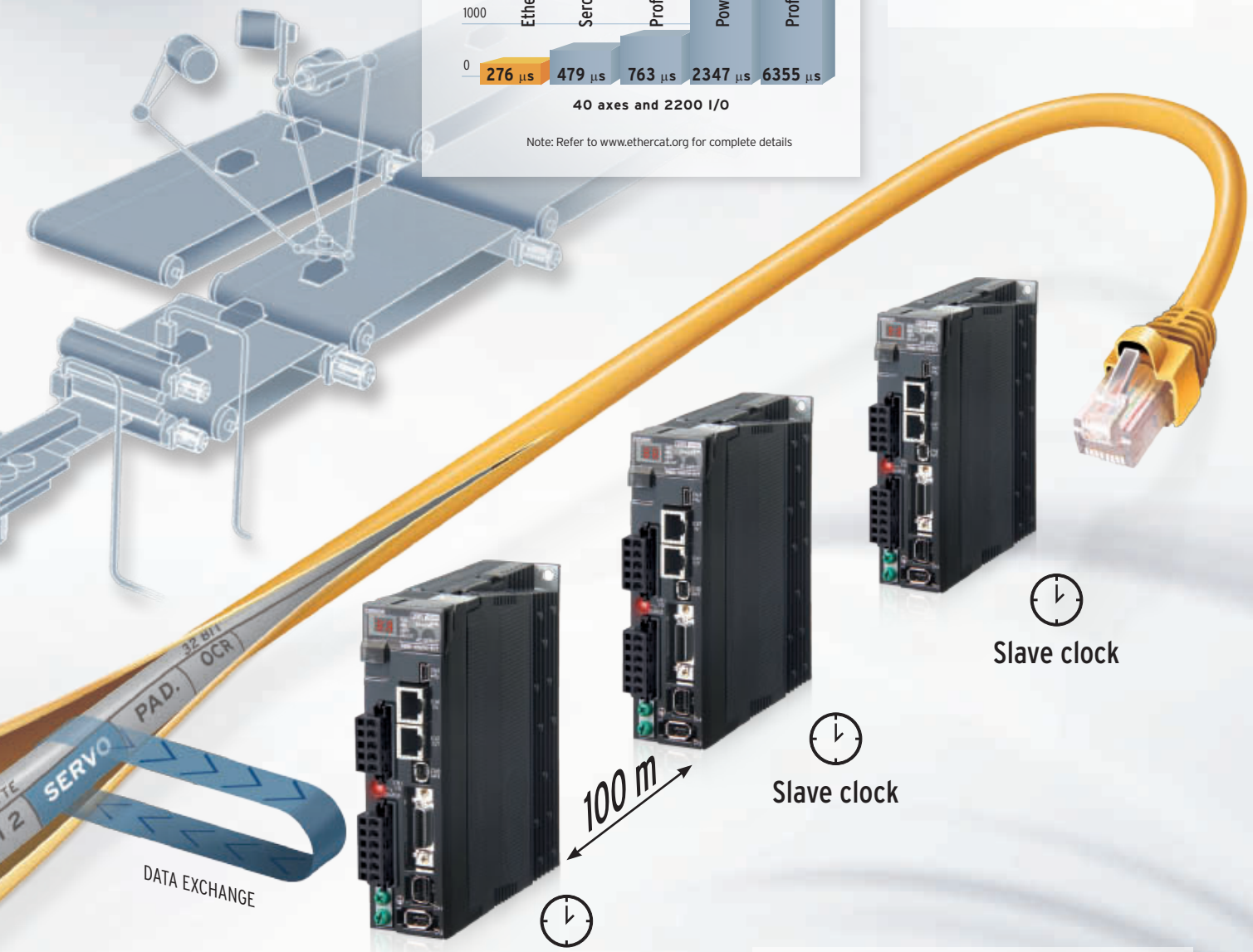

Flexible topology

With two EtherCAT ports on all devices, no additional switches are required to create a linear network. EtherCAT junctions can be used to build tree and star topologies, which can reduce the amount of cabling.

"On-the-fly" data exchange

The slave devices extract and/or insert data on the fly. This method assures the highest possible throughput.

Distributed clocks

The EtherCAT node slave measures the time difference between incoming and returning frame - timestamp-. With these timestamps the master can determine the propagation delay offset to the individual slave accurately. This mechanism ensures accurate synchronisation between devices with less than 1 μs jitter.

One software

Sysmac Studio for machine creators

Turning machine programmers into machine creators is the driving vision behind Sysmac Studio. Cutting programming, debugging and set-up time while maximising the functionality and performance of your machine is our ultimate goal. For this Sysmac Studio aims to offer ONE software for the complete machine. A software tool that only needs to be learned once, programmed, tested and tuned as one and secured as a whole.

Learn it **ONCE**
Develop it **FAST**
Test it as **ONE**
Secure it **ALL**



Learn it ONCE

- » One software for motion, drives and vision
- » Fully compliant with open standard IEC 61131-3
- » One design and operation environment for configuration, programming and monitoring

Develop it FAST

- » Supports Ladder, Structured Text and Function Block programming with a rich instruction set
- » CAM editor for easy programming of complex motion profiles
- » Intuitive editor with auto-complete assistance for Ladder and Structured Text programming

Test it as ONE

- » One simulation tool for sequence and motion in a 3D environment
- » Complete or partial program can be simulated and debugged
- » Data logging* and trending for tuning and debugging

Secure it ALL

- » Advanced security function with 32 digit security password.
- » Complete project or single Function Block* can be protected
- » Machine cloning prevention



* Available in Sysmac Studio above v1.0

One software

Sysmac Studio to develop machines

Created to give you complete control over your automation system, Sysmac Studio integrates configuration, programming and monitoring. Graphics-oriented configuration allows quick set-up of the controller, field devices and networks while machine and motion programming based on IEC standard and PLCopen Function Blocks for Motion Control cuts programming time. Smart Editor with On-line debugging helps quick and error free programming. Advanced simulation of sequence and motion control, data logging and data trace reduce machine tuning and set-up.

Design and operability

Unified design environment is provided for programming, configuration and monitoring. It also offers intuitive navigation between control modes.

Motion control

The graphical CAM editor allows quick implementation of complex motion profiles. CAM tables can be modified on the fly. A PLCopen Function Blocks for the Motion Control library are available to implement general purpose motion control.

Simulation

Motion trajectories in 3D can be pre-tested with advanced simulation of sequence and motion control. Simulation of single Function Blocks, POU's (Program Organisation Unit) or the entire program can be performed. In addition all standard features such as Break & Step are available.

Data logging* and tracing

Easy system tuning thanks to integrated and synchronised data tracing of motion commands, position and speed feedback and I/O status and values.

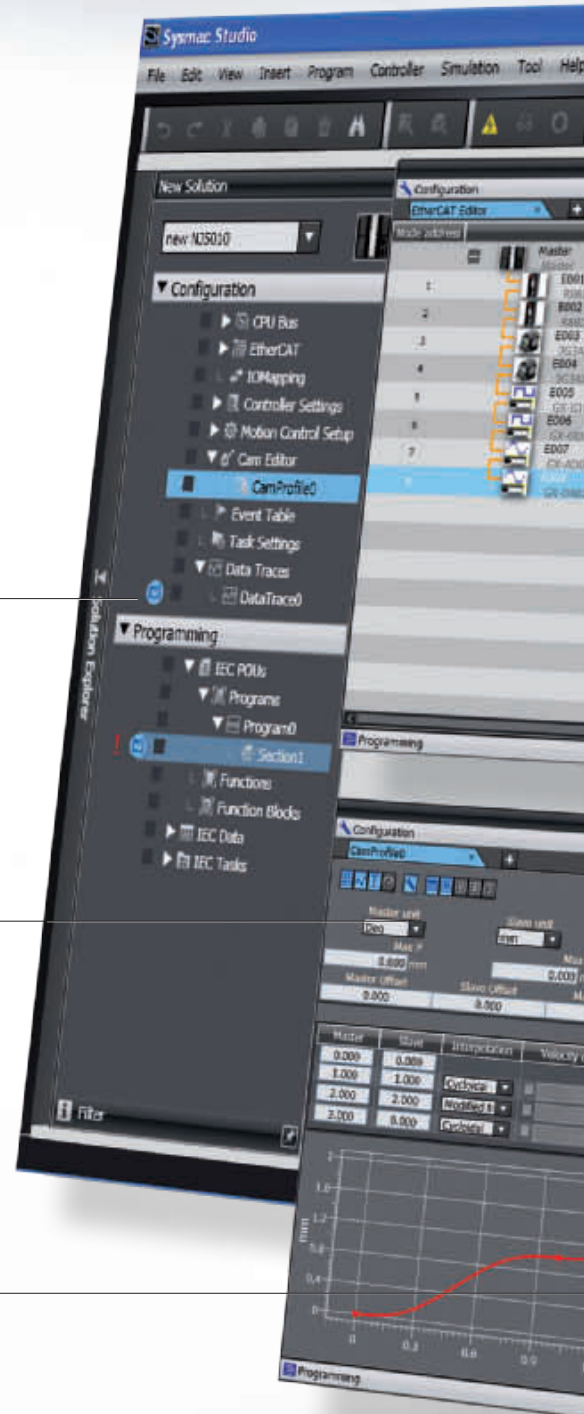

Configuration

Simple drag and drop configuration for controller, network, servo-axis and other field devices.

Programming

Multi-tasking and fully compliant with IEC61131-3 standard. The program editor includes smart support functions such as syntax error check and clear colour segregation of variables and symbols. ST instructions can be directly written in Ladder programs thanks to in-line ST function.



NJ-Series Machine Automation Controller

Complete and robust machine automation

The NJ-Series Machine Automation Controller is at the heart of the new Sysmac platform. One integrated machine controller that offers speed, flexibility and scalability of software centric architecture without compromising on the traditional reliability and robustness that you have come to expect from Omron PLCs. The NJ-Series is designed to meet extreme machine control requirements in terms of motion control speed and accuracy, communication, security and robust system. You just create...

Motion control

- Up to 64 axis control
- Single axis moves and axes interpolation
- 32 axes/ 1 ms cycle time
- Electronic cams and gearboxes

System robustness

- One event log for controller, field devices and networks
- Standard PLC system check: Watch-Dog Timer, memory check, network topology check, etc.

NJ-Series controller features

- Fast PLC tasks in 500 μ s
- Motion controller supporting up to 64 servo axes
- EtherNet/IP and EtherCAT ports embedded
- Up to 192 EtherCAT Slaves (64 axes)
- Standard IEC 61131-3 programming
- Certified PLCopen Function Blocks for Motion Control
- Linear and circular interpolation
- Linear and infinite axes management
- Electronic Gear and CAM synchronisation
- Global standards CE, cULus, NK, LR

Hardware design

- Architecture Based on new Intel CPU 1.6GHz
- The most compact controller in its class
- Built-in USB port and SD card slot
- Fan-less cooling



Machine control

- Seamless integration of Logic and Motion
- Synchronous control of all machine network devices
- Works with most CJ PLC series modules

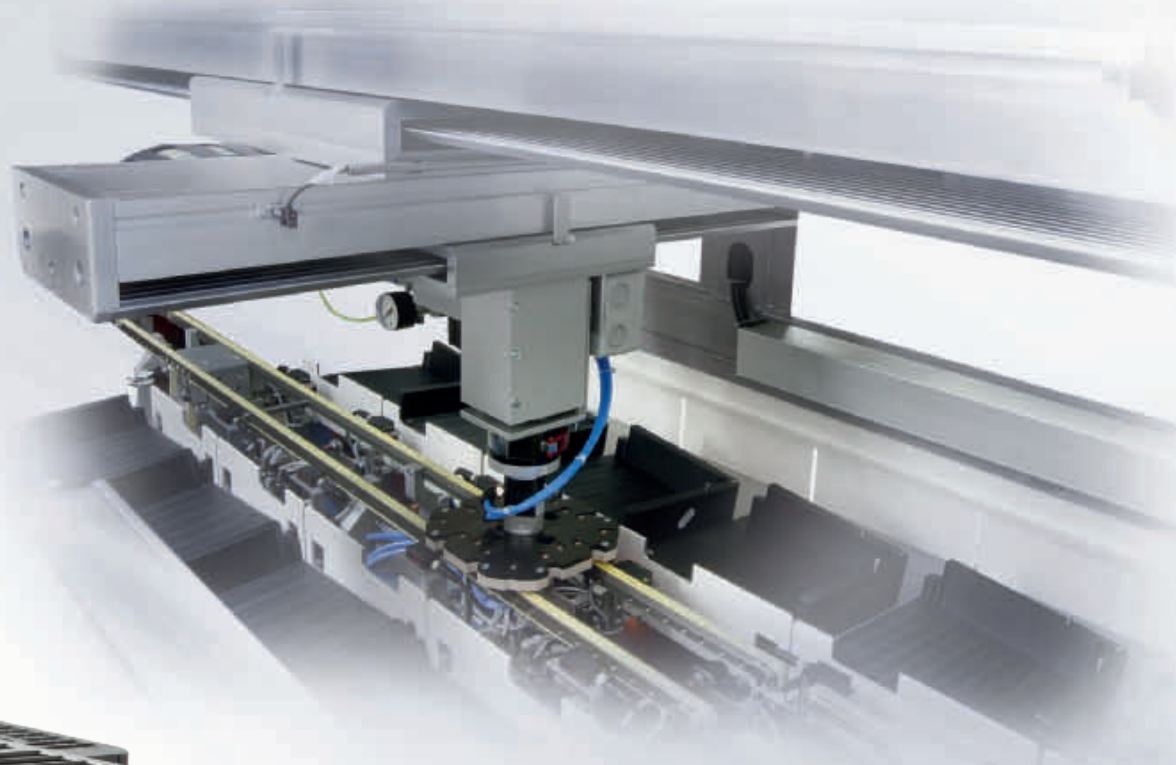

Standard Factory network

- Programming
- Other Machine controllers
- HMI / SCADA
- IT systems



Standard Machine network

- Servos
- Inverters
- Vision systems
- Distributed I/O



Standard programming

- Fully conforms IEC 61131-3 standards
- PLCopen Function Blocks for Motion Control



Accurax G5 Servo system

At the heart of every great machine

Great machines are born from a perfect match between control and mechanics. G5 gives you that extra edge to build more accurate, faster, smaller and safer machines.



EtherCAT connectivity

- Compliant with CoE -CiA402 Drive profile-
- Cyclic Synchronous Position, Velocity and Torque modes
- Embedded Gear Ratio, Homing and Profile Position mode
- Distributed clock to ensure high precision synchronisation



Accurax G5 servo system features

- Compact size servo drives with EtherCAT connectivity built-in
- High-response frequency of 2 kHz
- Load vibration suppression
- Embedded Safety conforming ISO13849-1 Performance Level d
- Advanced tuning algorithms (Anti-vibration function, torque feedforward, disturbance observer)
- Wide range of linear and rotary servo motors



Safety conformance

- PL-d according ISO13849-1
- STO: IEC61800-5-2
- SIL2 according to EN61508



Improved rotary motors

- Low cogging torque servo motors
- High accuracy provided by 20 bit encoder
- IP67 for all motors and connectors
- Large range of motors from 0.16 Nm up to 96 Nm nominal torque (224 Nm peak)

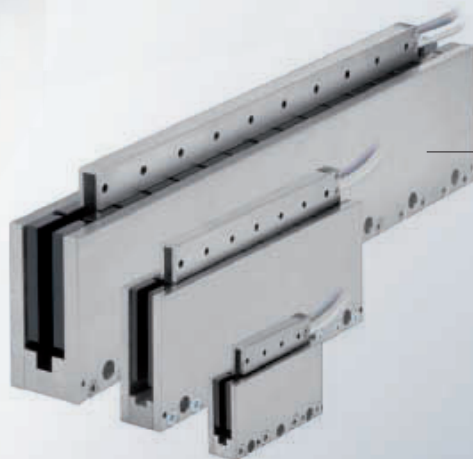

Ironless linear motors

- Compact, efficient design
- Excellent force-to-weight ratio
- No latching force

Iron-core linear motors

- Compact, flat design
- Optimum ratio between force and volume
- Weight-optimized magnetic track

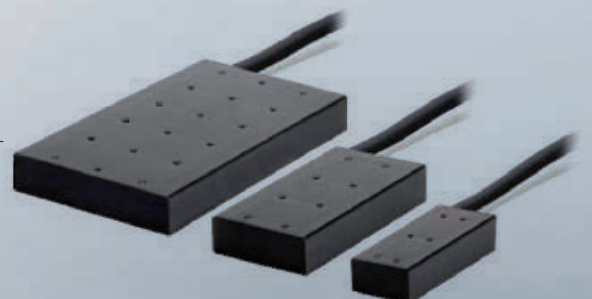

MX2 Inverter

Born to drive machines

Thanks to its advanced design and algorithms, the MX2 provides smooth control down to zero speed, plus precise operation for cyclic operations and torque control capability in open loop. The MX2 is fully integrated within the Omron Sysmac automation platform.

Torque control in open loop

- Ideal for low to medium torque applications
- Can replace a flux vector inverter or servo drive in suitable systems

EtherCAT

EtherCAT connectivity

- Compliant with CoE -CiA402 Drive profile-
- Velocity mode



MX2 features

- Torque control in open loop, ideal for low to medium torque applications.
- 200% starting torque near stand-still operation (0.5Hz)
- Double rating VT 120%/1 min and CT 150%/1 min



Quick response to load fluctuation

- MX2 provides accurate speed control with less than 2% error at 1 Hz
- Stable control without decreasing machine speed improves quality and productivity

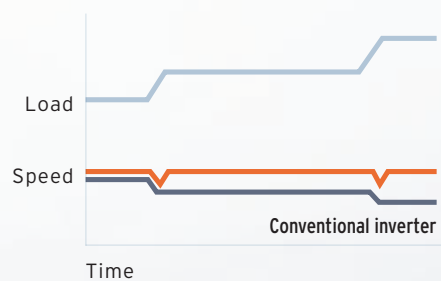

200% starting torque

- Near stand-still operation (0.5Hz)
- Smooth control of high inertia loads
- Control of fast cyclic loads

Frequency response vs Torque

(Example with 7.5kW 4-pole motor)

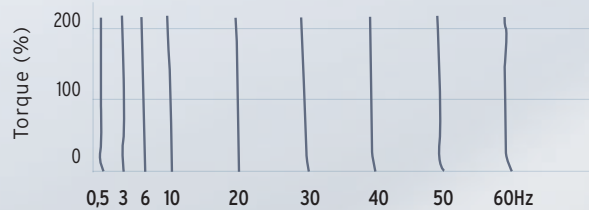

FQ-M Vision Sensor

Designed for object tracking

The new FQ-M series* is a vision sensor designed specifically for pick and place applications. It comes with EtherCAT embedded and can be configured and monitored from Sysmac Studio software. The FQ-M series is compact, fast and includes an incremental encoder input for easy tracking and calibration.



Connectivity

- EtherCAT port for object tracking
- Ethernet port for advanced configuration and monitoring
- Encoder input for accurate "on the fly tracking" and easy calibration
- Automatic strobe timing control

Detection

- Up to 5000 pieces per minute with 360 degree rotation
- Stable and robust detection under changeable environmental conditions

FQ-M features

- Made specifically for tracking applications
- Designed to work within Sysmac integrated automation with embedded EtherCAT and integrated software tool
- Smart camera with EtherCAT: camera, image processing and connectivity in one
- Vision sensor with encoder input for tracking function
- Calibration function of the complete system
- Can inspect a wide range of objects
- Sysmac Studio software for vision system operation and setting



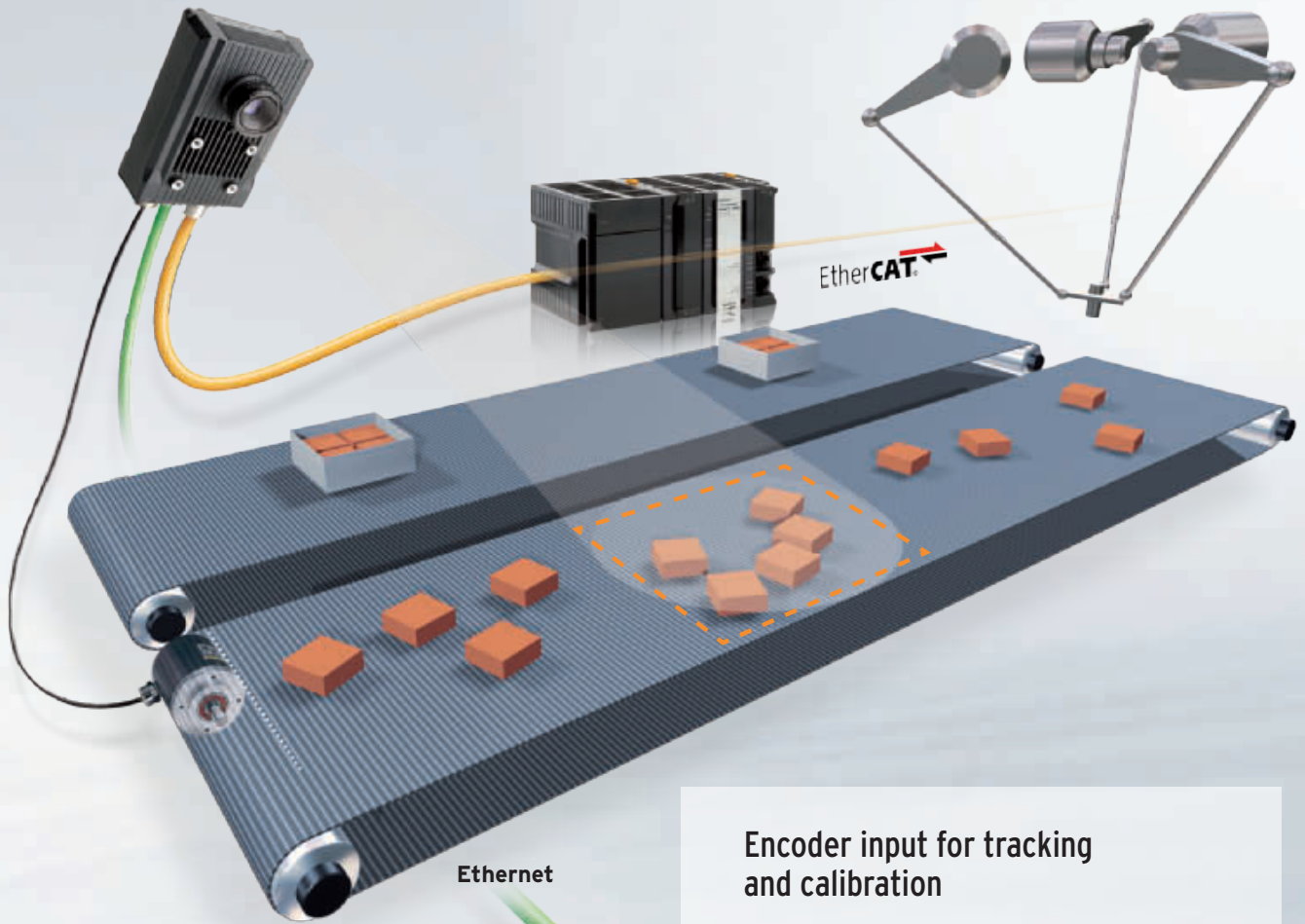

Encoder input for tracking and calibration

- » The assisted calibration procedure simplifies the overall system set-up.
- » Objects that overlap within more than one field of view are segregated and its data is ignored.

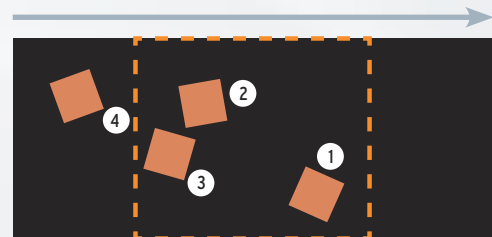

First shot: The position and orientation data of pieces 1, 2 and 3 are sent to the controller.

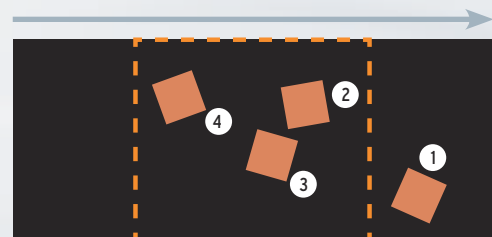

Next shot: Only the position and orientation data of piece 4 are sent to the controller.

Design

- Camera and image processing in one
- Standard C-mount lenses; choose the field of view and focus distance you need
- Variety of industrial connector types (angled, straight) for correct mounting

Software tool

- Fully integrated within the Sysmac Studio software tool
- Intuitive and icon driven set-up and configuration
- Trending and logging function

Service and Support



OMRON technical offices across the World

PRESENCE

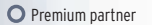
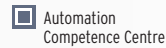

COMPETENCE

Design

OMRON



Our wide network of machine automation specialists will help you to select the right automation architecture and products to meet your requirements. Our flat structure based on expert-to-expert contact ensures that you will have ONE accountable and responsible expert to deal with on your complete project.

Proof of concept



As your project matures make use of our Automation centers to test and catch-up with technology trends in motion, robotics, networking, safety, quality control etc. Make use of our Tsunagi (connectivity) laboratory to interface, test and validate your complete system with our new machine network (EtherCAT) and factory network (EtherNet/IP).

We will assign a dedicated application engineer to assist with initial programming and proof testing of the critical aspects of your automation system. Our application engineers have in-depth expertise in and knowledge of networks, PLCs, motion, safety and HMIs when applied to machine automation.



CONFIDENCE

ASSURANCE

Development



During your prototyping phase you will need flexibility in technical support, product supply and exchange. We will assign an inside sales contact to help you source the correct products fast during your prototyping phase.

Commissioning



With our world-wide network for service and support the export of your product is made simple, we will support you on-site with your customer, anywhere in the world. We can arrange a liaison sales engineer to facilitate training, spare parts supply or even machine commissioning. All this in a localised language with localised documentation - giving you complete peace of mind.

Serial production



As your production increases we will engage in supplying you within 24hrs and repairing within 3 days. All our products are global products meeting global standards - CE, cULus, NK, LR -

Product overview

Controller



NJ-Series

- Integration of Logic and Motion in one Intel CPU
- Up to 64 axes motion control
- New PLC Logic and Motion cores, 100% Omron quality
- IEC 61131-3 programming languages
- EtherCAT and EtherNet/IP ports embedded
- Certified PLCopen Function Blocks for Motion Control
- Reuse with most of the CJ-series I/O units



Servos



Accurax G5 servo motor

- Power range from 50 W to 15 kW
- IP67 protection
- Low cogging torque



Accurax G5 servo drive

- High-response frequency of 2 kHz
- Built-in safety conforming ISO13849-1 Performance Level d
- High accuracy provided by 20 bit encoder
- Advanced vibration suppression functions



Accurax Linear motor solutions

- Linear motor force range from 26.5 to 760 N
- Ironless and iron-core motor types available
- Wide range of over 100 standard linear motor axes

Inverters



MX2

- Torque control in open loop
- 200% starting torque
- Double rating VT 120%/1 min and CT 150%/1 min

Vision sensor



FQ-M series*

- Camera, vision and connectivity in one
- Compact vision sensor
- Designed for high speed pick and place
- Encoder tracking and smart calibration function
- Fast and powerful object recognition

Distributed I/O



GX series

- Digital, analogue and encoder I/O units
- Removable I/O terminal
- Automatic and manual address setting



SmartSlice I/O

- Up to 64 I/O units per station
- Screwless wiring
- Hot-swap with auto-restore



Sysmac Studio

* Available as of autumn 2011

Austria

Tel: +43 (0) 2236 377 800
www.industrial.omron.at

Belgium

Tel: +32 (0) 2 466 24 80
www.industrial.omron.be

Czech Republic

Tel: +420 234 602 602
www.industrial.omron.cz

Denmark

Tel: +45 43 44 00 11
www.industrial.omron.dk

Finland

Tel: +358 (0) 207 464 200
www.industrial.omron.fi

France

Tel: +33 (0) 1 56 63 70 00
www.industrial.omron.fr

Germany

Tel: +49 (0) 2173 680 00
www.industrial.omron.de

Hungary

Tel: +36 1 399 30 50
www.industrial.omron.hu

Italy

Tel: +39 02 326 81
www.industrial.omron.it

Netherlands

Tel: +31 (0) 23 568 11 00
www.industrial.omron.nl

Norway

Tel: +47 (0) 22 65 75 00
www.industrial.omron.no

Poland

Tel: +48 (0) 22 645 78 60
www.industrial.omron.pl

Portugal

Tel: +351 21 942 94 00
www.industrial.omron.pt

Russia

Tel: +7 495 648 94 50
www.industrial.omron.ru

South Africa

Tel: +27 (0)11 608 3041
www.industrial.omron.co.za

Spain

Tel: +34 913 777 900
www.industrial.omron.es

Sweden

Tel: +46 (0) 8 632 35 00
www.industrial.omron.se

Switzerland

Tel: +41 (0) 41 748 13 13
www.industrial.omron.ch

Turkey

Tel: +90 212 467 30 00
www.industrial.omron.com.tr

United Kingdom

Tel: +44 (0) 870 752 08 61
www.industrial.omron.co.uk

More Omron representatives
www.industrial.omron.eu

Automation Systems

- Programmable logic controllers (PLC) • Human machine interfaces (HMI) • Remote I/O
- Industrial PC's • Software

Motion & Drives

- Motion controllers • Servo systems • Inverters • Robots

Control Components

- Temperature controllers • Power supplies • Timers • Counters • Programmable relays
- Digital panel indicators • Electromechanical relays • Monitoring products • Solid-state relays
- Limit switches • Pushbutton switches • Low voltage switch gear

Sensing & Safety

- Photoelectric sensors • Inductive sensors • Capacitive & pressure sensors
- Cable connectors • Displacement & width-measuring sensors • Vision systems
- Safety networks • Safety sensors • Safety units/relay units • Safety door/guard lock switches